

A Portable Device for Physiological Measurements in Biomedical Engineering Education

Olivera Tomašević¹, Luka Mejić¹,
Darko Stanišić¹, Vojin Ilić¹, Filip Gašparić¹

Abstract: The physiological data acquisition system described in this paper is developed for the purposes of student laboratory exercises in biomedical engineering program. The system has the functionality of electrocardiography and electromyography monitoring and can be used as a photoplethysmograph. Alongside the portability, other significant capabilities of the system are concerned with the resources that allow the system's complete functionality without the cable connections to other devices. Besides, the system's open architecture enables various types of expanding and modifications, which is suitable for student project realizations.

Keywords: Acquisition, Electrocardiography, Electromyography, Electrophysiology, Photoplethysmography.

1 Introduction

Among all the multidisciplinary scientific fields being incorporated in the Biomedical engineering domain, there is one specific field dealing with the principles of electrophysiological data acquisition system functioning. In the University of Novi Sad, Serbia, on the Biomedical engineering program, there has appeared a need for the development of a student electrophysiological data acquisition platform, which would enable students to become better acquainted with the basics of this scientific field.

Laboratory physiological measurement system development for the purpose of education in biomedical engineering has already been discussed in [1]. This paper described a real-time prototype system designed with an attempt for some biomedical instrumentation limitations to be overcome. The limitations regard portability, signal to noise ratio, universal and simple connectivity, on-line processing, user-friendliness, etc. The system was used for the acquisition of physiological signals such as electrocardiographic (ECG) and photoplethysmographic signal. The acquisition was achieved with the use of microphone input and sound card, and MATLAB software was used for signal processing and display.

¹Faculty of technical sciences, University of Novi Sad, Trg Dositeja Obradovica 6, 21000 Novi Sad, Serbia;
E-mails: olivera.tomasevic@uns.ac.rs; mejic@uns.ac.rs; darkos@uns.ac.rs; vojin@uns.ac.rs;
filip.gasparic@uns.ac.rs

The physiological data acquisition system proposed in [2] was intended for the educational and research development purposes, as well. This portable device was realized on a Raspberry PI platform, implemented two System-on-Chip solutions and functioned as an ECG recorder and an impedance cardiographer (ICG). The recordings were transferred via Bluetooth to a PC, where they were displayed, along with certain hemodynamic parameters. The similar functionalities and the same purpose were accomplished by a Raspberry PI based mobile system proposed in [3].

Another mobile system for ECG and ICG continuous monitoring was proposed in [4]. The recordings were transferred to a PC via Bluetooth, where they were displayed in the Mat lab application.

In [5], a physiological measurement system has been described that would be applied on students during the learning process in order to examine the teaching effect. The signals were acquired on a sensor stage, and then wirelessly transferred to a sensor node. The data was sent from the sensor node to a PC computer through the RS232 interface, and then displayed in a real-time application in LabVIEW.

All previous solutions used a PC as a means of signal (processing and) display. However, researchers in the field, for these purposes, also tend to exploit a vast availability of mobile devices like smartphones. For instance, a portable device based on a Raspberry PI platform, presented in [6] integrated a wireless transfer module and acted like a communication bridge between the ECG front end and a personalized mobile device application used for an ECG visualization. [7] proposed an Android based system for the assessment of the person's physiology and behavior in phobias. During the follow-up of the reactions to context dependent audio-visual stimuli, the physiological responses were acquired with an ECG measuring device and behavior was observed through the accelerometer/gyroscope and GPS measurements. The Android based system application comprised of both, the monitoring and the stimulus exposure feature. Another android-based physiological data acquisition system was presented in [8]. The system functioned as a portable ECG device applicable in telemedicine. Namely, the acquired signals were transferred via Bluetooth to a smartphone with Android operating system, after which they were becoming accessible to a remote health provider.

Another system for the purposes of telemonitoring was proposed in [9]. The 'Impact Shirt' incorporated integrated textile electrodes, textile wiring, and portable miniaturized hardware. It allowed continuous ECG and ICG measurements and a wireless data transmission via Bluetooth to a mobile phone with Android operating system or a PC computer.

The physiological data acquisition platform presented in this paper is a compact portable device with an open architecture design, designed for

electrocardiographic, electromyographic (EMG) and photoplethysmographic signal acquisition. The multifunctionality, open architecture design, and user-friendliness renders it appropriate for the use in student laboratory exercises. [10]

2 The Method

2.1 System overview

The system consists of an electrophysiological measurement module, pulse oximeter measurement module, an application development platform and a wireless LAN module. A block diagram of the system is shown in Fig. 1.

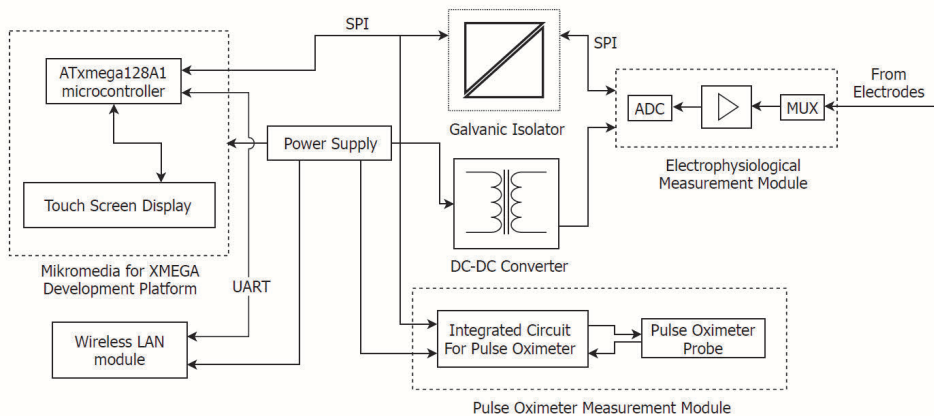

Fig. 1 – System block diagram.

The electrophysiological measurement module is used for the acquisition, signal processing and analog-to-digital (A/D) conversion of the electrophysiological signals. It integrates multiple channels, and each has an antialiasing filter, a built-in programmable gain amplifier (PGA), and a 24-bit, simultaneous-sampling delta-sigma ($\Delta\Sigma$) analog-to-digital converter (ADC). Different electrophysiological module configurations are set using a field of programmable switches (MUX on Fig. 1).

The pulse oximeter module performs the primary processing of the signals for the photoplethysmography. It consists of an integrated circuit AFE4490 [11] and a pulse oximeter probe with LEDs and a photodiode. Integrated circuit provides the excitation of LEDs and amplification of signals from the photodiode.

The Mikromedia for XMEGA development platform [12] is equipped with all the hardware resources necessary for a physiological data acquisition system development. Its central part is the ATxmega128A1 microcontroller (Microchip) [13], which regulates the process of physiological signals

acquisition, processing and display. The signal is displayed on a TFT 320x240 touch screen display. This display enables a high-quality user interface for system configuration and signal monitoring. Other significant resources of the platform are the SPI communication module for the communication interface with physiological modules, the USB connector for applying a power supply to the system and allowing data transfer to/from a PC computer, and a microSD card slot for the data recording. The platform also contains a Li-Polymer battery connector for a battery power supply implementation. This enables the device to be completely independent of other devices, and makes it a handheld one.

Along with the USB protocol utilization, data transfer to/from other devices can be achieved wirelessly, as well. This is accomplished with the use of a Wireless LAN module. The communication between the microcontroller and a Wireless LAN module is realized using the UART communication protocol.

The electrophysiological module is isolated from the microcontroller system. The isolation of the communication line is achieved using the isolation module, and the isolation from the power network is achieved using an isolated DC-DC convertor module. The interface between the respondent and the pulse oximeter module is optoelectric, so no additional galvanic isolation of electronic circuits is required.



Fig. 2 – *The physiological data acquisition system, assembled (on the left) and unfolded (on the right).*

There are two versions of the system depending on the Electrophysiological measurement module realization. Integrated circuits used in the formation of this module are ADS1298 [14] and ADS1299 [15] (Texas Instruments), and the system is pin compatible with both. ADS1298 is specially designed for ECG measurements - it contains three integrated amplifiers that generate the Wilson central terminal (WCT) and the Goldberger central terminal (GCT) required for

a standard 12-lead ECG. ADS1299 is suitable for all biopotential measurements. As far as the programming of these circuits is concerned, the difference between the two is in a couple of registers, which is mainly caused by the ECG-specific features of the circuit ADS1298.

The photograph of the system is shown in Fig. 2. Detailed hardware description of the system can be found in [16].

2.2 System software modules

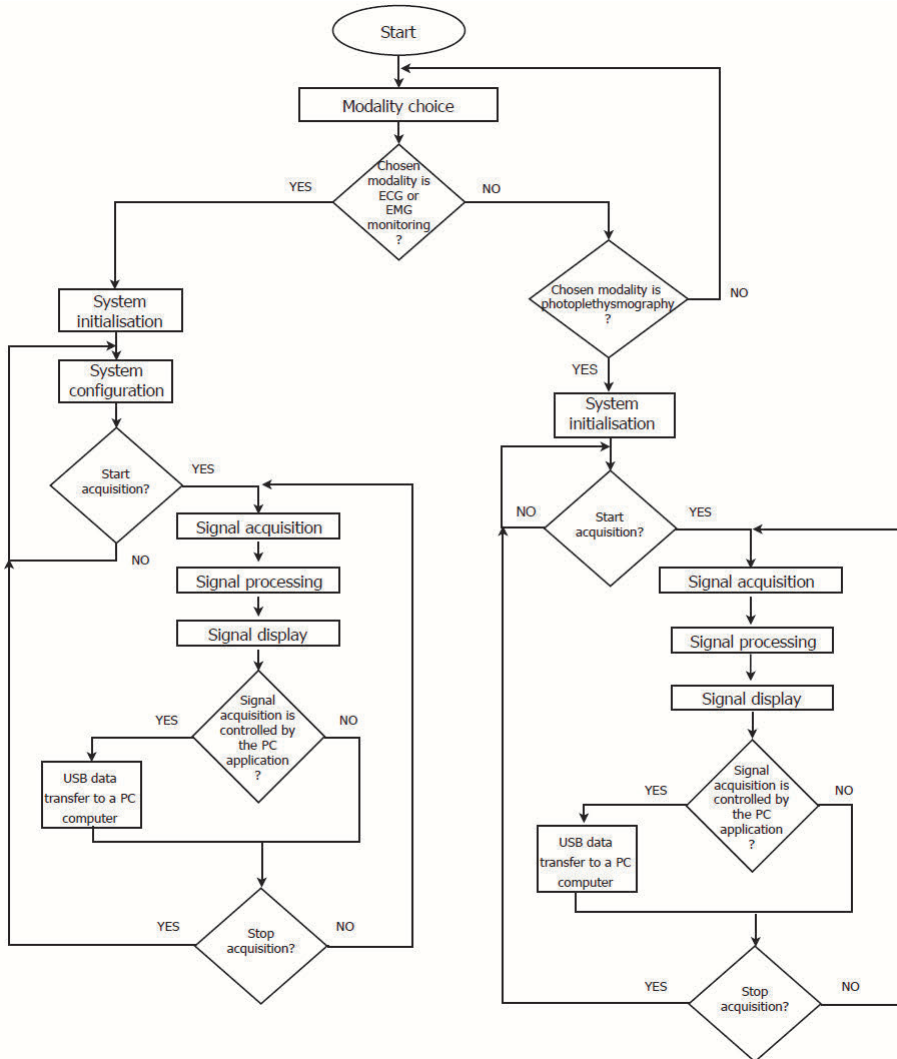

Fig. 3 – The system software block diagram.

The entire software structure referring to electrophysiological and pulse oximeter module functioning is shown in Fig. 3. The realized software modules allow the acquisition, digital processing and display of the physiological signals on the system's TFT display. The system software is written in development tools microC PRO for AVR (ver. 6.1.2, mikroElektronika, Serbia) and VisualTFT (ver. 4.6.1, mikroElektronika, Serbia).

According to the user's choice upon the active physiological modality (Modality choice block in Fig. 3), the system functions as an electrocardiograph, electromyograph or pulse oximeter. The screen for the modality choice (Fig. 4) is shown on the display upon switching the device on.

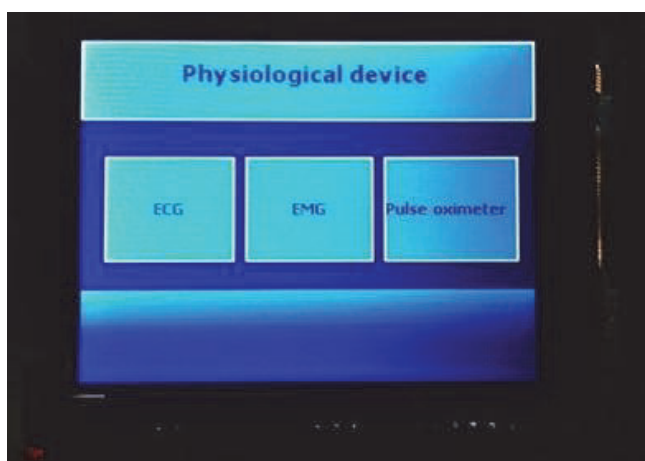

Fig. 4 – *The screen for the physiological modality choice.*

Regardless of which modality is selected, in order for the signal acquisition process to be enabled, the module corresponding to the selected modality, as well as the microcontroller must be initialized. This process is represented by a System initialization module in Fig. 3. The initialization of the physiological module, whether it is the electrophysiological or pulse oximeter module, refers to the signal acquisition parameter settings.

The electrophysiological module has a set of registers for parameter settings same for all the channels and a set of registers for the channel-specific settings. The parameters which are the same for all the channels are, for instance, the sampling rate of the data acquisition, and the activation of a BIAS drive amplifier for the derivation of the Right Leg Drive output signal. The channel-specific parameters are the one such are the PGA gain values.

The pulse oximeter module mainly has two types of registers – the registers that are used for configuration and the registers that contain the sampled data. As the AFE4490 firmware implements a state machine, the configuration

registers are used to set the timings, i.e. start time and stop time, for every single state. The value of every register represents the number of cycles of the internal 4 MHz clock at which the operation correlated with that register should start or stop.

The initialisation of AFE4490 starts by defining the sampling frequency in number of clock cycles and writing it to the related register. After that, it can be defined when and what will happen during the one sampling cycle. One major sampling cycle should implement 4 minor samplings: sample ambient light → sample LED1 → sample ambient light → sample LED2, where every minor sampling consists of multiple operations, e.g. LED1 switch on, sampling start, start ADC conversion, sampling stop, LED1 switch off.

The system configuration module in Fig. 3 implies on the signal display parameter settings. In case of electrophysiological signal acquisition, signal display parameters can be adjusted by the user on the Settings screen (Fig. 5) when this module is chosen. These parameters are concerned with the time and amplitude scale of the displayed signal. The time scale parameter represents the duration of a signal section that can be seen on the screen. The optional values for this parameter are 1, 5 and 10 s. The amplitude scale parameter represents the maximum signal amplitude that can be shown on the screen. The optional values for this parameter are 50 μ V, 0.5 mV and 5 mV. These values are selected in accordance with the expected amplitudes of the EMG and ECG signals, respectively.



Fig. 5 – The screen for an electrophysiological signal display parameter settings.

There is no system configuration module for the photoplethysmography. The time scale has a fixed value, and the amplitude scale is determined

automatically and updated for each new signal section that is being displayed on a single screen. Namely, the amplitude scale for the currently displayed signal waveform is determined based on the maximum and minimum value of the previous signal section.

The Signal acquisition module in Fig. 3 implies on the process of the data transmission from the physiological modules to the microcontroller. The A/D conversion on the electrophysiological module and the data transfer to the microcontroller is initiated after the OK button on the Settings Screen (Fig. 5) is pressed. In Fig. 3 this is found as the START ACQUISITION command when the chosen modality is ECG or EMG monitoring. Similarly, the A/D conversion on the pulse oximeter module and the data transfer to the microcontroller is initiated after the START button on the screen for the photoplethysmographic signal display is pressed. In Fig. 3 this is found as the START ACQUISITION command when the chosen modality is photoplethysmography. The screen for the photoplethysmographic signal display is shown in Fig. 6.



Fig. 6 – The screen for the photoplethysmographic signal display.

The physiological data is sent in the form of a packet data sequence. The electrophysiological signal values are represented in the two's complement format, so the actual values are obtained only after the data conversion to the decimal equivalent. The decimal equivalent is additionally scaled with respect to the A/D converter resolution and reference voltage, and specified PGA gain value. The final values are expressed in millivolts (mV). The photoplethysmographic signal values are represented as unsigned values. The actual values are obtained after the data conversion to the decimal equivalent, and are expressed in A/D units related to the A/D converter of the pulse oximeter module.

After the acquisition, signals are processed and displayed. However, not every acquired sample will be shown on the screen. The number of the shown samples depends on the display time scale, which is, as mentioned before, set by the user for the electrophysiological recording, or has a fixed value for the photoplethysmography.

Signal processing (the signal processing module in Fig. 3) depends on the chosen physiological recording type. Namely, in case of the electrophysiological recording, it consists of digital filtering, and in case of photoplethysmography, it consists of digital filtering and calculations of certain physiological parameters.

The electrophysiological signals are filtered by the second order high pass digital Butterworth IIR filter. This is done for the purposes of the signal DC offset suppression, which is a consequence of the half-cell potential developed at the electrode-skin contact. Considering that the selected sampling frequency of the system is different in cases of ECG and EMG signal acquisition, the filter coefficient values are different for each electrophysiological recording type, as well.

The photoplethysmographic signals are digitally filtered by a high pass filter for the purposes of suppressing the DC offset, as well. Suppressing the DC offset is important for the correct signal display.

Besides the digital filtering, the signal processing module implemented for the purposes of photoplethysmography executes the calculations of the peripheral oxygen saturation (SpO₂) expressed in percentages and heart rate (HR) expressed in beats per minute (bpm). The physiological parameters are determined based on the intensity of the transmitted red and infrared light which passes through the tissue and is detected on the photodiode. All the parameters are calculated and updated over the signal sections corresponding to the predefined time period. The SpO₂ is calculated in the following way:

$$SpO_2 = 110 - 25 \frac{AC_{red} DC_{ir}}{AC_{ir} DC_{red}}.$$

The variables AC_{red} and AC_{ir} denote the variability of the red and infrared photoplethysmographic signals, respectively. They are calculated as the difference between the signal maximum and minimum value. At the same time, the terms DC_{red} and DC_{ir} denote the mean values of the red and infrared photoplethysmographic signals.

By the definition, HR is a number of beats per minute, i.e. the repetition frequency of a QRS complex in the ECG signal, expressed in 1/min. In the calculation, it is considered that this frequency corresponds to the repetition frequency of photoplethysmographic signal maximum value. In accordance, the

HR is calculated as the reciprocal value of the mean repetition period of the signal maximum value.

The signal display module in Fig. 3 refers to the signal display on the system's TFT display. However, the signals can be displayed on the PC computer as well. The data transfer to/from the PC computer is realized through the USB communication interface, whereby the signal processing and display is performed in the Matlab (ver. R2015a, MathWorks, USA) application. The application allows the signal acquisition start and stop control through the graphical user interface, while the commands are forwarded to the device by the means of the USB communication interface. The physiological data is transmitted to the PC computer only if the signal acquisition start command was assigned by the application.

The STOP acquisition command in Fig. 3 is assigned either by the display user interface on the device, or by the graphical user interface on the PC computer. This command deactivates the A/D converter of the physiological module, regardless of the module specified, and consequently, stops the physiological data transmission to the microcontroller.

3 Results

This chapter represents the results of the physiological signal acquisition and the examples of the screen images on both, the system's TFT display and the PC computer.

Figs. 7 and 8 represent the electrophysiological signals displayed on the TFT display. Fig. 7 represents the EMG signal produced by the biceps brachii muscle while performing contractions. The chosen maximal amplitude range for the signal display is 1 mVpp, while the duration of a displayed signal section is 5 s. Fig. 8 represents the ECG signal measured in the first bipolar lead configuration. The chosen maximal amplitude range for the signal display is 1 mVpp, while the duration of a signal section being seen on the screen is 5 s.

Because of the digital filtering process, the signals are set around the baseline - a horizontal line located in the middle of the graphics, as can be seen in the figures.

When the BACK button located on the screen for the electrophysiological signal display (Figs. 7 and 8) is pressed, the A/D module of the electrophysiological module is deactivated and the display returns to the Settings screen.

The signals were acquired at all 8 channels, but only one channel, chosen by the user, can be displayed at a time.

Fig. 9 represents the photoplethysmographic signal originated from the infrared diode displayed on the TFT display of the device. It is displayed along

with the calculated values of SpO₂ and HR. The duration of a signal section seen on the screen is 5 s. When the STOP button located on the screen for the photoplethysmographic signal display is pressed, the A/D module of the photoplethysmography is deactivated and the acquisition is stopped.

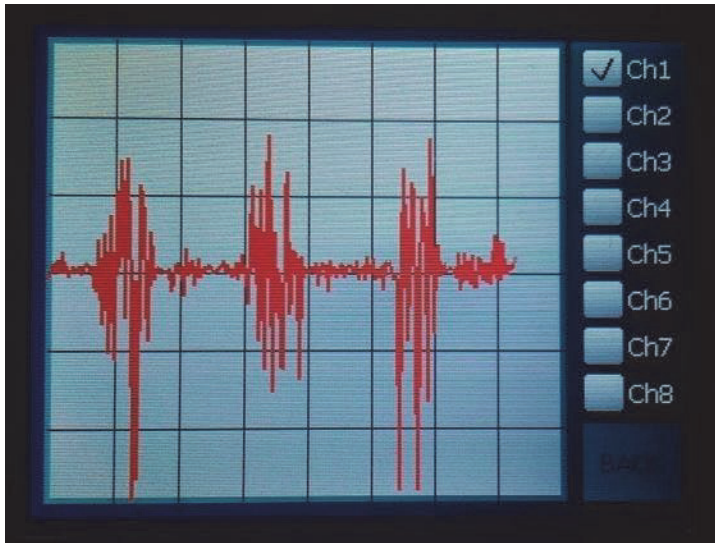

Fig. 7 – EMG signal displayed in duration of 5s with maximal display amplitude range of 1 mVpp.



Fig. 8 – ECG signal displayed in duration of 5s with maximal display amplitude range of 1 mVpp.

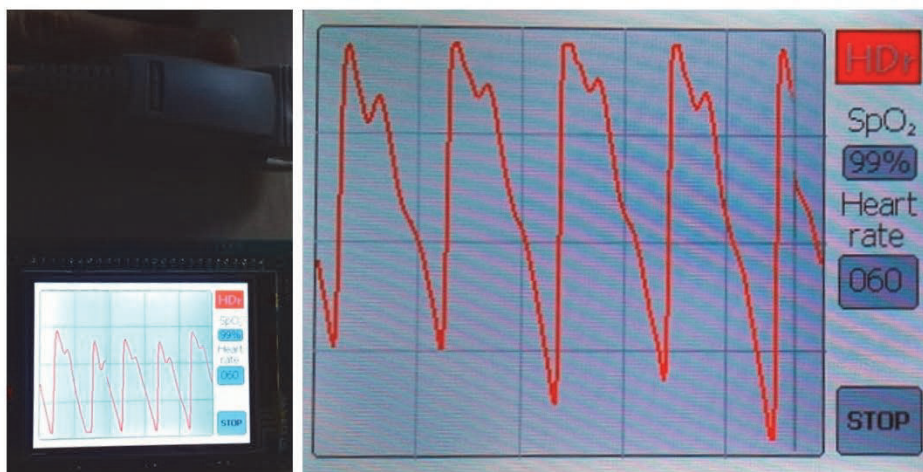

Fig. 9 – Photoplethysmographic signal display.

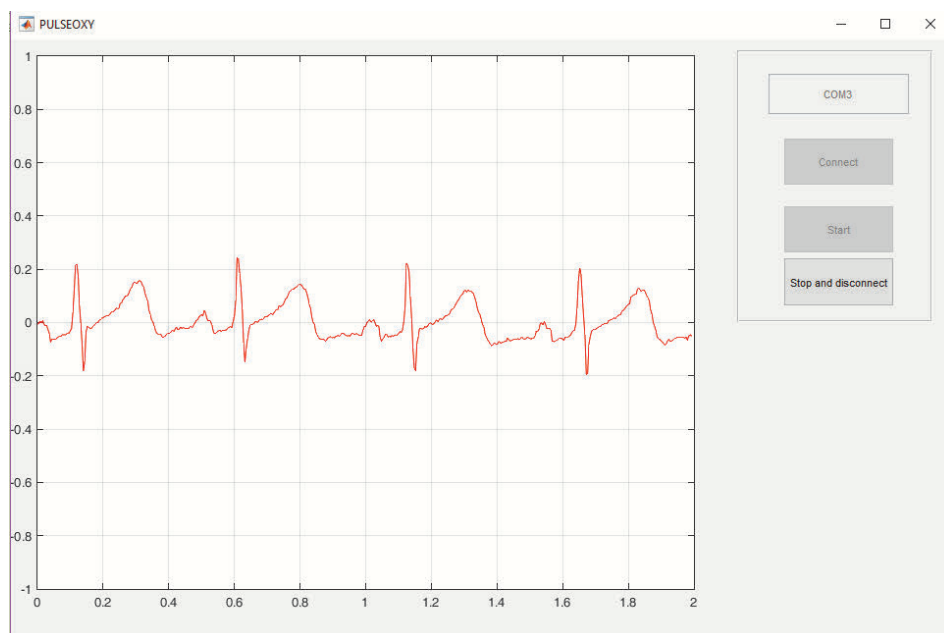

Fig. 10 – ECG signal displayed in Matlab application in the duration of 2s, expressed in mV.

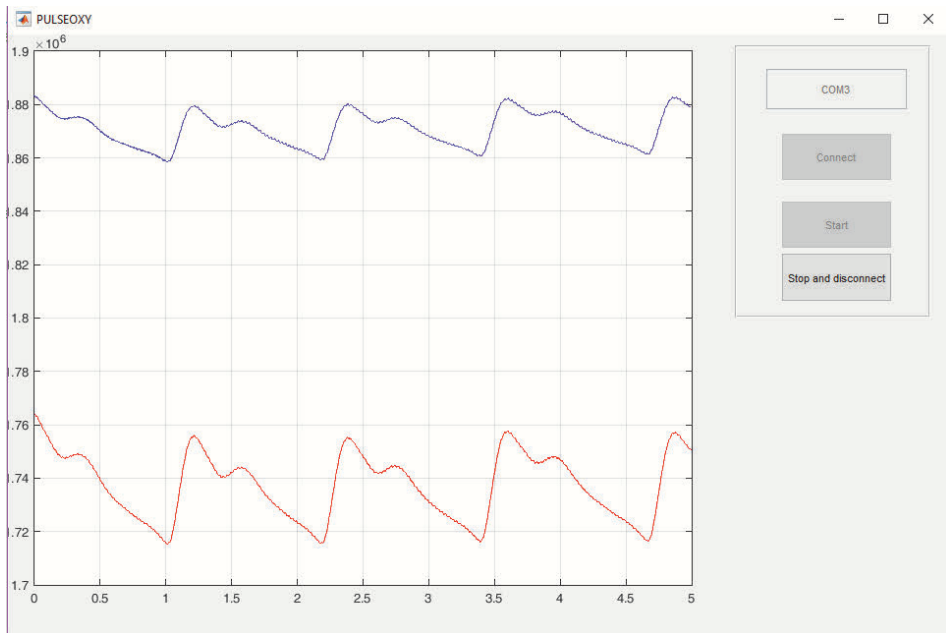

Fig. 11 – Photoplethysmographic signals displayed in Matlab application, in the duration of 5 s, expressed in A/D units of the A/D converter of the pulse oximeter module.

Figs. 10 and 11 represent the electrophysiological and photoplethysmographic signals displayed in the Matlab (ver. R2015a, MathWorks, USA) application on a PC computer, respectively. Signal acquisition on the microcontroller, and consequently, on the PC computer is controlled by the user through the Connect, Start and Stop and disconnect button located in the application window seen in both figures. The Connect button is used for connecting the application to the serial port assigned to the USB interface through which the data transmission is to be performed. When the Start button is pressed, the signal acquisition on the microcontroller and the data transmission and display on a PC computer is initiated. When the Stop and disconnect button is pressed, the signal acquisition on the microcontroller and the PC computer is stopped and the application is disconnected from the serial port through which the data transmission is performed.

3 Conclusion

The comparison of this system and the systems mentioned in the introduction imposes the following noticeable similarities: the portability, the possibility of a wireless data transmission to other devices, and a multifunctionality in the sense of acquiring different types of physiological

signals or parameters. The similarity with certain systems is also an open system architecture and an educational purpose. One significant difference between these and the presented system, is in the process of signal display. Previously mentioned examples of physiological data acquisition systems in the terms of signal display mainly depend on the connection to a PC computer or a smartphone. The solution regarding the signal display on a TFT display presented in this paper is useful because it enables immediate detection of the signal and different artifacts caused by, for example, movements of electrodes or cables. It also enables an immediate detection of software malfunctioning, which is useful in a system software implementation process. Another advantage of the system caused by the existence of the display is that it does not have to be connected to other devices in order for the signal to be displayed.

Besides the display, the system contains its own memory for the data recording, an onboard battery connector, and a capability of a wireless data transfer to other devices. Therefore, it can be completely functional without the cable connections to other devices, and suitable for applications that involve use of a holter device.

This paper dealt with the electrophysiological recording and photoplethysmography, but did not demonstrate a wireless communication and a battery power supply implementation, so those are the topics for future work.

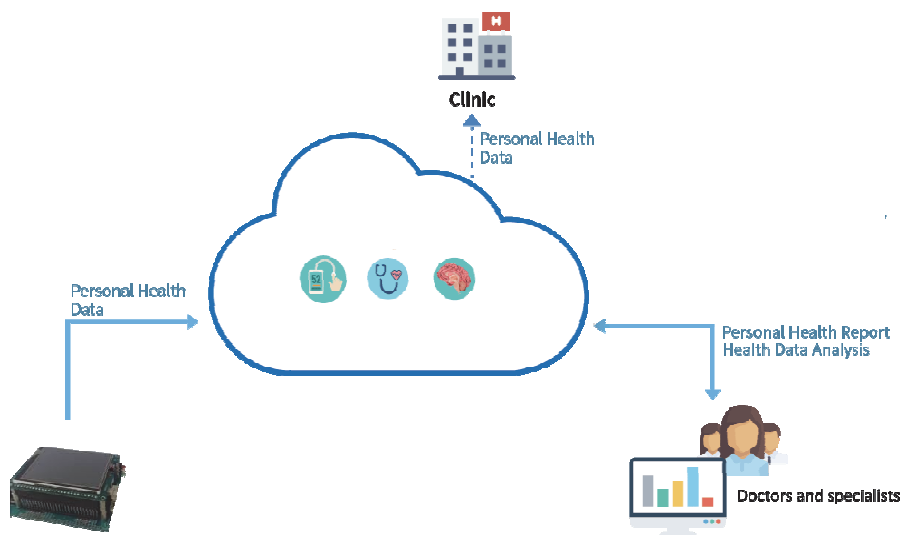

Fig. 12 – *The concept of remote supervision of the physiological parameters by the health providers.*

If implemented, a wireless data transfer to other devices would allow a remote insight into the physiological signals and parameters of the user. This would imply an automatic data transmission from the device to the Cloud server, whereupon the data would be accessible to the remote user through a PC based application on a local computer. The similar concept could be used in telemedicine, where the physiological data is remotely accessible to the medical specialists (Fig. 12).

Finally, considering that the main purpose of the system is educational, here are some ideas for student exercises, which would involve the utilization of this laboratory system. First, the system could be used in laboratory exercises of a course where the basics of electrophysiological signal acquisition are presented. Students would analyze the system architecture, and then work in pairs in order to record electrophysiological signals that could later be analyzed. After the basics of this course are adopted, the students could develop a PC application regarding the processing of the recorded signals. This would involve the implementation of different filtering mechanisms, and the extraction of specific signal features. The requirements on a potential project could also be a different application design for the signal acquisition, processing and display on a PC computer. And finally, the student task could be a further enhancement of the system performances, either with software, or with hardware development.

4 References

- [1] R. Stojanović, D. Karadaglić: An Economical and Feasible Teaching Tool for Biomedical Education, Proceedings of the 24th International Symposium on Computer-Based Medical Systems (CBMS), Bristol, UK, June 2011, pp. 1 – 5.
- [2] A. Hafid, S. Benouar, M. Kedir–Talha, F. Abtahi, M. Attari, F. Seoane: Full Impedance Cardiography Measurement Device Using Raspberry Pi3 and System-on-Chip Biomedical Instrumentation Solutions, IEEE Journal of Biomedical and Health Informatics, Vol. 22, No. 6, November 2018, pp. 1883 – 1894.
- [3] S. Weyer, T. Menden, L. Leicht, S. Leonhardt, T. Wartzek: Development of a Wearable Multi-Frequency Impedance Cardiography Device, Journal of Medical Engineering and Technology, Vol. 39, No. 2, February 2015, pp. 131 – 137.
- [4] W. Zhang, S. Jing, L. Gui, Y. Zhang: Physiological Data Acquisition System for Education Assessment Using Wireless Sensor Network, Proceedings of the International Conference on Information Technology and Application in Biomedicine, Shenzhen, China, May 2008, pp. 471 – 473.
- [5] C. A. Valliappan, A. Balaji, S. R. Thandayam, P. Dhingra, V. Baths: A Portable Real Time ECG Device for Arrhythmia Detection Using Raspberry Pi, Proceedings of the 6th International Conference on Wireless Mobile Communication and Healthcare (MobiHealth 2016), Milan, Italy, November 2016, pp. 177 – 184.
- [6] T. Cruz, S. Brás, S. C. Soares, J. M. Fernandes: Monitoring Physiology and Behavior Using Android in Phobias, Proceedings of the 37th International Conference of the IEEE Engineering in Medicine and Biology Society (EMBC), Milan, Italy, August 2015, pp. 3739 – 3742.

- [7] J. Hinestroza, A. Lias, R. Silva: Development of a Tele-ECG Device, IFMBE Proceedings of the VI Latin American Congress on Biomedical Engineering CLAIB 2014, Paraná, Argentina, Vol. 49, October 2014, pp. 833 – 836.
- [8] M. Ulbrich, J. Muhlsteff, A. Sipila, M. Kamppi, A. Koskela, M. Myry, T. Wan, S. Leonhardt, M. Walter: The IMPACT Shirt: Textile Integrated and Portable Impedance Cardiography, *Physiological Measurement*, Vol. 35, No. 6, June 2014, pp. 1181 – 1196.
- [9] O. Tomašević, L. Mejić, D. Stanišić, V. Ilić: Physiological Data Acquisition System for a Biomedical Engineering Education, *Proceedings of the 5th International Conference IcETRAN*, Palić, Serbia, June 2018, pp. 712 – 715.
- [10] AFE4490 Integrated Analog Front-End for Pulse Oximeters datasheet, Texas Instruments, SBAS602B, December 2012–Revised February 2013.
- [11] Mikromedia for XMEGA Manual, Ver. 1.11, MikroElektronika, 2012.
- [12] 8-bit Atmel XMEGA A Microcontroller XMEGA, A MANUAL 8077I–AVR 11/2012, Atmel.
- [13] ADS129x Low-Power, 8-Channel, 24-Bit Analog Front-End for Biopotential Measurements, ADS1294, ADS1294R, ADS1296, ADS1296R, ADS1298, ADS1298R, Texas Instruments, SBAS459K, January 2010–Revised August 2015.
- [14] ADS1299-x Low-Noise, 4-, 6-, 8-Channel, 24-Bit, Analog-to-Digital Converter for EEG and Biopotential Measurements, ADS1299, ADS1299-4, ADS1299-6, Texas Instruments, SBAS499C, July 2012–Revised January 2017.
- [15] N. Jorgovanović, M. Stanković, Ž. Tepić, V. Ilić, D. Bojanić: Laboratory System for Physiological Measurements, *Proceedings of the 1st International Conference on Electrical, Electronic and Computing Engineering, IcETRAN*, Vrnjačka Banja, Serbia, June 2014, pp. MEI1.5 1 – 4.