

## Development of the System for Abdominal Aortic Aneurysm Mechanical Properties Research Using “Bubble Inflated” Method

Ivan Milanković<sup>1</sup>, Nikola Mijailović<sup>2</sup>, Igor Končar<sup>3</sup>,  
Dalibor Nikolić<sup>1</sup>, Nenad Filipović<sup>2</sup>, Aleksandar Peulić<sup>4</sup>

**Abstract:** The main goal of this paper was to determine the biomechanical parameters of abdominal aortic aneurysm using the Bubble Inflated method. In other words, the main task of this paper was to develop a system which would be able to increase the pressure of physiological saline which affects blood vessel tissue and causes its deformation. This deformation is recorded using a camera and providing data at each moment about pressure values which affect tissue and were detected by using a pressure sensor.

**Keywords:** Bubble Inflated method; Abdominal aortic aneurysm; Pressure sensor; Physiological saline.

### 1 Introduction

Abdominal aortic aneurysm is a disease that manifests as a localised expansion of part of the largest blood vessel [1]. This expansion is caused by a gradual decrease in the firmness and elasticity of the wall of abdominal aorta and usually involves a weakness in the middle layer of the aorta which results in stretching of the outer layer. The blood that the heart pumps under pressure through the aorta gradually stretches the weakened wall and usually produces aneurysms in the form of a “bubble”, like a hen's egg. An aneurysm on the wall may contain deposits of cholesterol, calcium, or small blood clots [2].

It is very useful to expose part of the vessel, removed during surgery, to *in vitro* measurements of mechanical parameters such as modulus of elasticity, the force cracking under uniaxial and biaxial stress, etc. These data are entered into the medical history along with other data, and can be used as a parameter for

---

<sup>1</sup>Research and Development Center for Bioengineering BioIRC, Prvoslava Stojanovića 6, 34000 Kragujevac, Serbia; E-mails: milankovic88@gmail.com, E-mail: markovac85@kg.ac.rs

<sup>2</sup>Faculty of Engineering, University of Kragujevac, Sestre Janjić 6, 34000 Kragujevac, Serbia; E-mails: nmijailovic@kg.ac.rs, fica@kg.ac.rs

<sup>3</sup>Department of Vascular and Endovascular Surgery, Clinical Center of Serbia, Dr Koste Todorovića 8, 11000 Beograd, Serbia; E-mail: dr.koncar@gmail.com

<sup>4</sup>Faculty of Technical Sciences, University of Kragujevac, Svetog Save 65, 32000 Čačak, Serbia; E-mail: aleksandar.peulic@ftn.kg.ac.rs

evaluating the condition of the vessel after surgery, thereby possibly providing information on the speed of recovery or any complications in the future. Alternatively, these data can be used for purely scientific research purposes.

There are a number of methods used for determining the mechanical parameters of tissue some of which utilise blood vessel tissue stretching in one direction and record the force and elongation [3], with others involving stretching it in two directions, the so-called biaxial stretching of tissue [4], as well as tissue inflation [5]. This paper describes a system that was implemented for the determination of characteristics of tissue affected by aortic aneurysm using the so-called “Bubble Inflated” method.

## 2 “Bubble Inflated” Method

There is growing interest in determining the biomechanical properties of blood vessel tissues. Inflation of a circular membrane of some samples to determine the mechanical parameters presents a technique which has been practically used in both engineering and scientific practice since 1944, when it was used for the determination of characteristics of rubber for making elastic tires, with compressed air used as a working fluid [6]. This method has been refined over the years in terms of the technique and the theory and mathematical formulae that were involved; as a result, it is still popular.

A piece of material with a circular cross section is fixed on its edge, with a spherical structure formed under the influence of fluid pressure and material elasticity, as presented in Fig. 1.

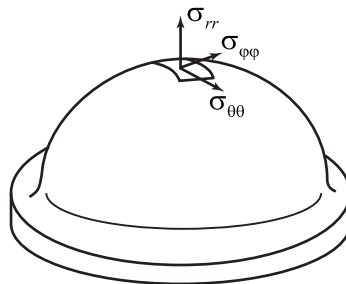

**Fig. 1** – *Appearance of an inflated balloon during stress.*

In this way, as a result of inflation, we can show an example of biaxial strain on the top of the balloon and plane strain on the edge, so that the Cauchy stress tensor has the following reduced form:

$$\sigma = \begin{bmatrix} \sigma_{rr} & 0 & 0 \\ 0 & \sigma_{\theta\theta} & 0 \\ 0 & 0 & \sigma_{\theta\theta} \end{bmatrix}. \quad (1)$$

The relationship between the thickness of the sample,  $e$ , the pressure difference inside and outside the sample,  $P$ , and the radius of curvature,  $R$ , is given in the following equation:

$$\sigma_{00} = \frac{P \cdot R}{2e}. \quad (2)$$

During the experiment, the pressure, i.e. the pressure difference, can be obtained by using a corresponding sensor, while the radius of the curvature can be determined with the help of a camera, so that it is possible to determine the thickness of the tissue. If we assume that the thickness is uniform, both before and after inflation, and using the equation of conservation of volume of the sample, we have the following relation:

$$e = e_0 \left( \frac{l}{l_0} \right)^2. \quad (3)$$

In this equation,  $e_0$  presents the initial sample thickness and  $l_0$  and  $l$  present curve lengths at the initial point and at the point when the tissue thickness is equal to  $e$ , respectively.

### 3 Description of the System Designed for the Experiment

In order to determine blood vessel tissue biomechanical parameters using the “Bubble Inflated” method, a system consisting of a pump, heater, heat exchanger, pressure sensor, camera, and control unit was designed.

The pump, heater, heat exchanger and pressure sensor are the parts of the system which are responsible for adjusting and determining the current value of the pressure of physiological saline which acts on blood vessel tissue and providing the appropriate temperature to the physiological saline. The pump adjusts the pressure of the physiological saline, and the pressure sensor provides information about its value. The sensor is supplied with a voltage 12-36 V<sub>DC</sub>, and outputs a current of 4-20 mA, which reflects the change in pressure of the physiological saline. A heater is used to heat the distilled water in order to adjust the temperature of the physiological saline to 37°C, regardless of their physical mixing, since heating the physiological saline in the heater is not allowed in order to prevent chemical reactions that could alter the composition of the physiological saline.

The camera has the task of monitoring the deformation of blood vessel tissue while the pressure of the physiological saline which acts on the tissue is rising, and has a sampling frequency of 1fps (frames per second), thus providing an image resolution of 1000×1000 pixels at 96 dpi (dots per inch).

The control unit is responsible for synchronisation of the entire system, and enables communication with the computer via the USB interface in order to

design graphical changes in the pressure of the physiological saline in real-time, as well as displaying images from the camera output. Taking into account the described functionality, the hardware for the control unit was designed as presented in Fig. 2.

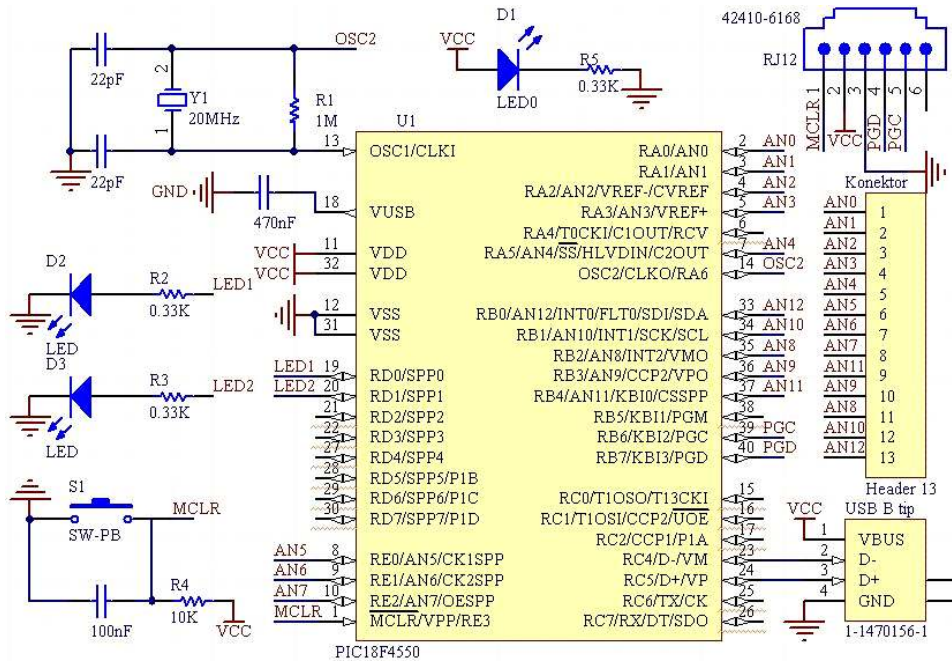

Fig. 2 – Scheme of control – acquisition unit.

The central part of this scheme presents the microcontroller unit U1. When selecting a microcontroller, it has to be taken into account that this part must be capable of USB communication, A/D conversion, and a sufficient number of input and output pins; as a solution, the Microchip PIC18F4550 microcontroller was selected. Therefore, communication between the control unit and computer was achieved using the USB interface, and the conversion of analogue signals from the output of the pressure sensor to digital values was performed using the A/D converter that is built-in into the microcontroller. Since the pressure sensor has a current output of 4-20mA, and the A/D input should be in the range of 0-5V, there is, in parallel with the output of the sensors, a resistor of 250Ω connected, so that the input A/D converter voltage is in the range of 1-5V, which reflects the changes in pressure of physiological saline. In a situation where the input A/D converter voltage was less than 1V, this would indicate that there had been a failure.

To enable the described microcontroller functionalities, first we needed to program the same. For this purpose, an RJ12 connector was used, through which the microcontroller was connected to a computer to upload .hex files into its memory.

For control unit power supply, a DC voltage of 5V was required, which was provided by the computer through the USB interface. Besides the above described components, the scheme also included some LEDs for signalling, a reset button, and a number of additional inputs for A/D conversion.

As stated above, the computer communicated with the system via the USB interface. On the computer, there was an application that collected data of the physiological saline pressure changes and drew a graph in real-time, as well as displaying images from the camera output. This application also created a text file which included data about measured pressure, as well as a folder in which all of the images were stored; this enabled the flow of the whole experiment to be shown later, for demonstration purposes.

#### 4 Experimental Part

Before the experiment was performed, the system had to assume the initial state. The blood vessel tissue needed to be set up in a suitable container to prevent the physiological saline from leaking during the pressure increase. The air was removed from the system and the temperature of the saline was adjusted to 37°C. Fig. 3 shows the whole system that was developed for the experiment.

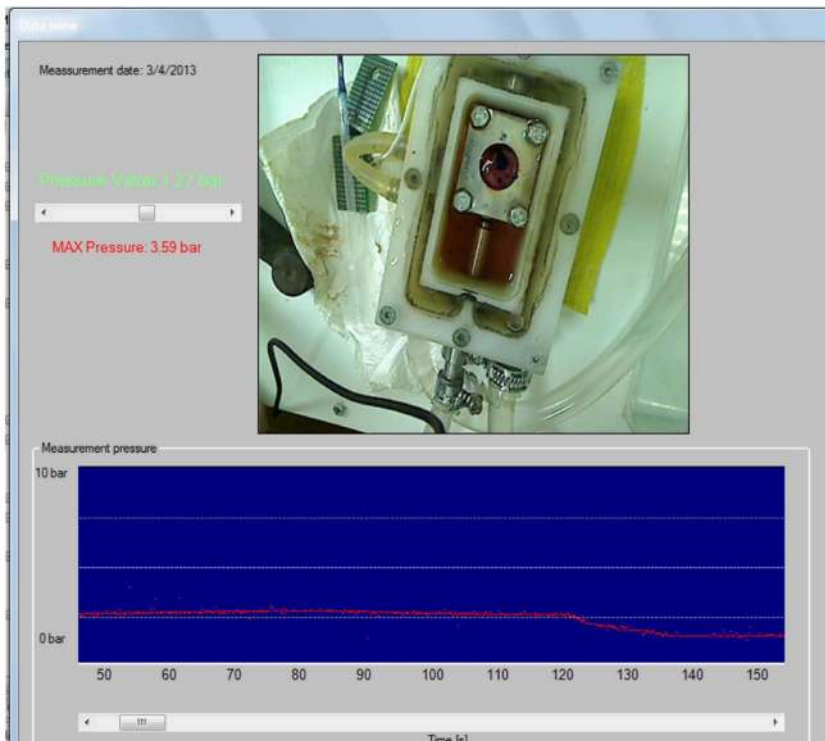

Fig. 3 – Architecture of the system designed for the experiment.

After tissue fixing for a cylinder hole, the system was connected to a PC via a USB port and the pump began removing air from the system. The warmed distilled water heated the saline in the heat exchanger to a temperature of 37°C.

When the initial conditions were satisfied, the experiment could begin. The pump gradually increased the pressure of physiological saline on the tissue and caused tissue deformation. The control unit, with a pressure sensor, recorded the pressure and a webcam performed video acquisition of the deformed tissue.

The software application was responsible for showing and archiving pressure values and the corresponding video data in real-time. Fig. 4 shows the sample window of the acquisition software.



**Fig. 4** – Appearance of the window with simultaneous display of images of tissue and pressure in real-time.

A preview of the pressure changes during the experiment is shown in Fig. 5. The pressure increased linearly until it reached the maximum value, that is, until a break occurred in the tissue, after which the pressure dropped sharply.

Fig. 6 shows the deformed tissue species with corresponding pressure values.

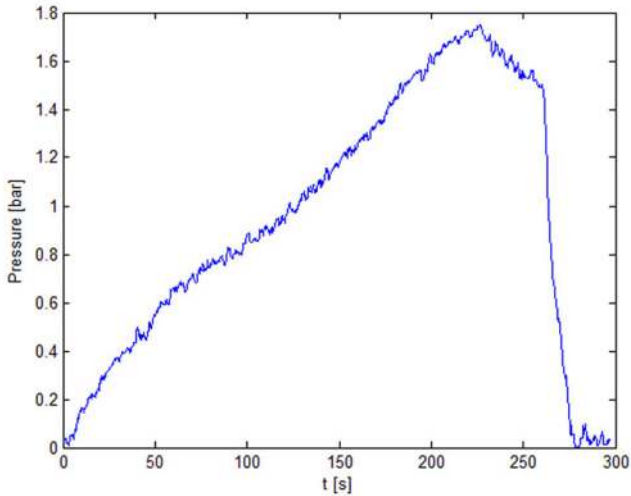

**Fig. 5** – *The pressure value during the tissue inflation.*

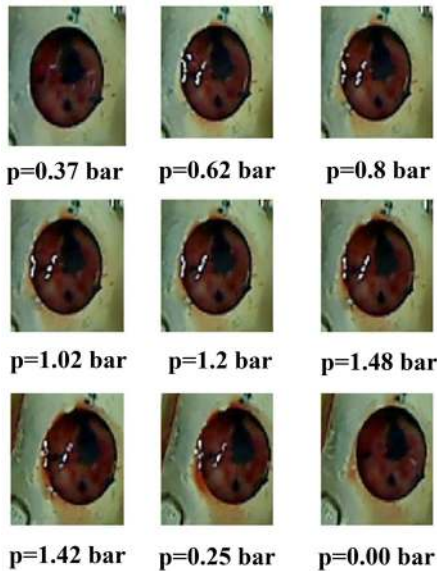

**Fig. 6** – *The tissue deformation for different pressure values.*

The tissue was marked with black waterproof paint, as shown in Fig. 7, and the ratio of this black area was calculated using the appropriate image processing technique to determine the vertical displacement. This area ratio depends on the deformation value and the view angle of the camera.

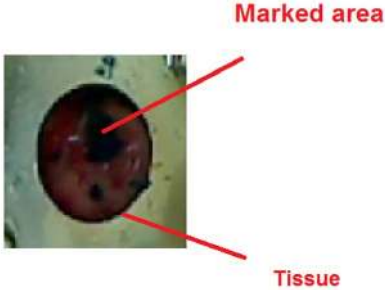

Fig. 7 – Tissue species with black waterproof painted area.

Fig. 8 presents the correlation between the pressure applied and the maximal vertical displacement of the tissue species for a number of experimental points. According to nine characteristic points, we can see that tissue reserves a certain amount of displacement ratio after the pressure decreases due to a reduction of elasticity in the aortic aneurysm tissue.

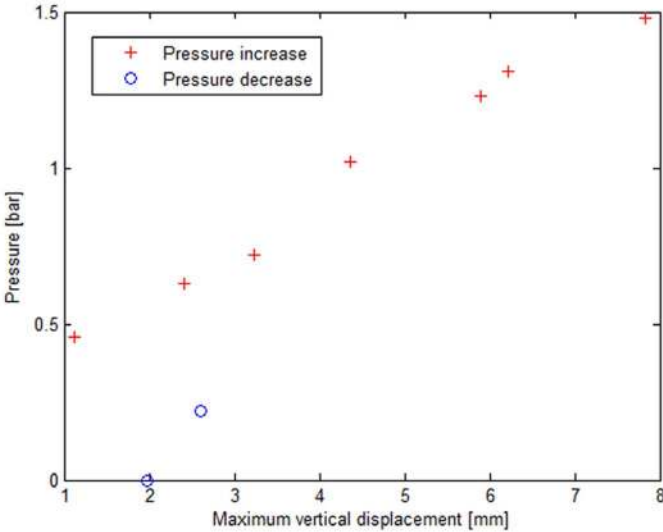

Fig. 8 – Maximum vertical deformation of tissue in the case of pressure increase and decrease.

At the end of this section, there is the question about error values and uncertainty, which are calculated in this case by displacement determination. The error sources are finite numbers of pixels of used images, the uncertainty of



the view angle of the camera, boundary pixels of the marked area and camera lens distortion; therefore, it is not easy to exactly determine this value. If we only consider the finite number and boundary pixel, the assessment of error ratio is around 1.5 mm for maximal vertical displacement.

## 5 Conclusion

In this paper, the development and realisation of a system for abdominal aortic aneurysm tissue mechanical properties research using the “Bubble Inflated” method is presented. By measuring deformation and pressure values, it is possible to determine Young's modulus of elasticity which, for a specified patient, can be useful for assessment of the state of blood vessels. It was assumed that the blood vessel tissue is isotropic homogeneous media and the problem is spherically symmetrical.

More accurate analysis can be obtained by using a system of two or more cameras and tissue marked with waterproof paint meshes, which would allow more precise deformation data to be obtained; this should be the subject of future studies.

## 6 Acknowledgements

This paper was supported by the Ministry of Education Science and Technological Development of the Republic of Serbia (project) III41007 and OI-175008.

## 7 Literature

- [1] S.S. Hans, O. Jareunpoon, M. Balasubramaniam, G.B. Zelenock: Size and Location of Thrombus in Intact and Ruptured Abdominal Aortic Aneurysms, *Journal of Vascular Surgery*, Vol. 41, No. 4, April 2005, pp. 584 – 588.
- [2] A.A. Noel, P. Głowiczki, K.J. Cherry Jr, T.C. Bower, J.M. Panneton, G.I. Mozes, W.S. Harmsen, G.D. Jenkins, J.W. Hallett Jr: Ruptured Abdominal Aortic Aneurysm: The Excessive Mortality of Conventional Repair, *Journal of Vascular Surgery*, Vol. 34, No. 1, July 2001, pp. 41 – 46.
- [3] D.P. Sokolis, E.M. Kefaloyannis, M. Kouloukoussa, E. Marinos, H. Boudoulas, P.E. Karayannacos: A Structural Basis for the Aortic Stress–strain Relation in Uniaxial Tension, *Journal of Biomechanics*, Vol. 39, No. 9, 2006, pp. 1651 – 1662.
- [4] J.A. Stella, J. Liao, M.S. Sacks: Time-dependent Biaxial Mechanical behaviour of the Aortic Heart Valve Leaflet, *Journal of Biomechanics*, Vol. 40, No. 14, 2007, 2006, pp. 3169 – 3177.
- [5] A.J. Slifka, E.S. Drexler, J.E. Wright, R. Shandas: Bubble-test Method for Synthetic and Bovine Vascular Material, *Journal of Biomechanics*, Vol. 39, No. 10, pp. 1939 – 1942.
- [6] A. Brunon, K. Bruyere-Garnier, M. Coret: Characterisation of the Nonlinear Behaviour and the Failure of Human Liver Capsule through Inflation Tests, *Journal of the Mechanical Behaviour of Biomedical Materials*, Vol. 4, No. 8, Nov. 2011, pp. 1572 – 1581.