

# Experimental Study of the Behaviour of the Crosstalk of Shielded or Untwisted-Pair Cables in High Frequency

Benazza Baghdadi<sup>1</sup>, Bendaoud Abdelber<sup>2</sup>, Reineix Alain<sup>3</sup>,  
Dafif Omar<sup>3</sup>, Slimani Helima<sup>2</sup>

**Abstract:** Electromagnetic disturbances from natural phenomena such as lightning, or those generated from industrial activity, can cause harmful interference in on-board electronic systems. The disturbances are generally transformed into radiated and conducted disturbances, using wired connections to spread their effects in electrical and electronic systems. In order to identify the paths of propagation and coupling of these HF currents into a complete system and propose solutions to reduce EMC interference, it is necessary and important to carry out experimental case studies on the coupling between shielded as well as unarmoured cables, in order to identify the importance of differential and common-mode currents. Measurements were made using a 4-way vector network analyser giving the results of the crosstalk between victim and culprit cables as well as for module and phase.

**Keywords:** EMC shielded cable, crosstalk, electromagnetic interference, common mode, differential mode.

## 1 Introduction

The study of coupling in wiring network systems is one of the main concerns for electromagnetic compatibility. However, the modelling of power lines has been a treaty problem for many years [1]. For example, the accuracy sought in the impedances of a motor will only have meaning if the latter power cable is also considered.

Shielded conductors have been the subject of numerous studies [2]. It should be noted that cable lengths can become very large (several tens of metres) implying that propagation effects cannot be neglected when the disturbance spectrum is in HF [3].

---

<sup>1</sup>Application of plasma, Electrostatics and Electromagnetic Laboratory (APELEC), Univ Ctr of Ain Temouchent, Algeria

<sup>2</sup>Application of plasma, Electrostatics and Electromagnetic Laboratory (APELEC), Djillali Liabès University of Sidi Bel-Abbès, Algeria

E-mails: benazza13@yahoo.fr; b Abdelber@gmail.com; slimani.halima@yahoo.fr

Without forgetting that twisted cables and unshielded twisted pairs of cables can provide a potential solution to reduce electromagnetic interference, their effect depends on various parameters, such as the layout of the cable ends [4].

In this paper, an experimental setup was studied, the coupling between a shielded pair of cables and an unshielded thread in order to measure the influence of the grounded shield. We also measured the common mode and differential mode currents with data from adequate measurements using a four lanes vector network analyser (which allowed us to make accurate measurements before performing the calibration phase required when working with high frequencies).

## 2 Background on the Phenomenon of Crosstalk Coupling Cables

### 2.1 Reminder of the concept of common and differential mode

Propagation of conducted emissions is achieved in two ways [5, 6]:

#### *Common Mode Disturbances (CMD)*

These emissions are generated by the current flow that propagates in all conductors in the same direction and the return is through the earth or ground plane, as shown in Fig. 1. This trend is mainly due to the parasitic capacitances in the system that are sensitive to variations in voltage and  $dv/dt$  products on the lines.

#### *Interference Differential Mode (IMD)*

These are caused by the current flow that propagates in a first conductor in one direction and returns through the other conductor in the opposite direction (Fig. 2). This current is primarily due to the parasitic inductances of the system, which are sensitive to changes in current  $di/dt$  generated on the conductors.

Tests were conducted on both a short circuit and an open circuit, to determine the characteristic impedance  $Z_c$  of the line that is different from the value of the internal impedance measuring devices, generally equal to  $50 \Omega$ . To adapt the line, the impedance transformers (or 'balun') are sometimes used and adapted for the frequency bands of interest.

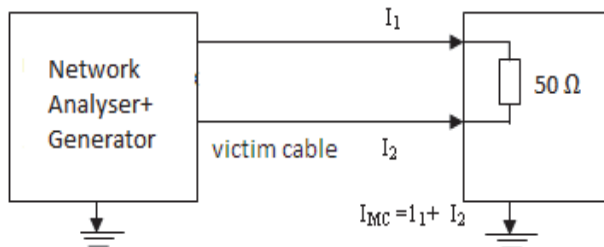
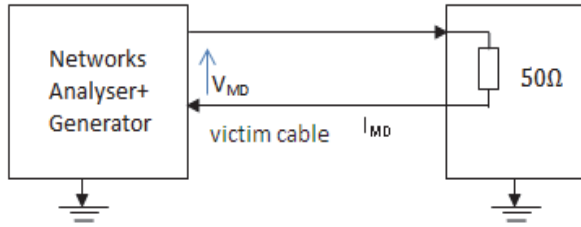
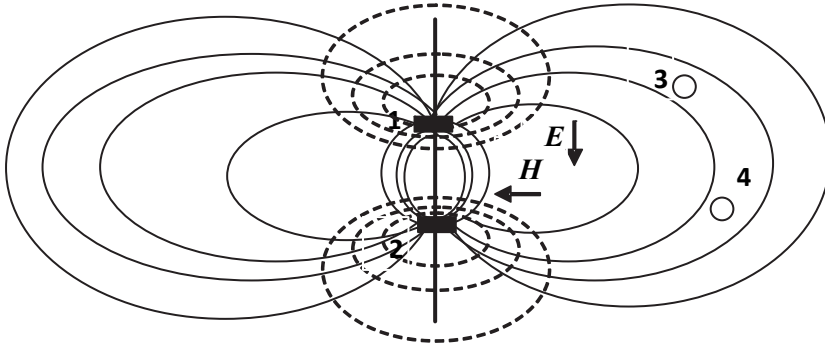

Fig. 1 – Circulation of common mode currents  $I_{MC}$ .



**Fig. 2** – Current circulation in Differential Mode  $I_{MD}$ .

The crosstalk is a coupling mode that approximates the field cable coupling (Figs. 3 and 4). Fig. 3 shows the electromagnetic field and the interaction effects of conductor lines.



**Fig. 3** – Representation of the electromagnetic field of a line with two conductors (1 and 2) and the influence on an adjacent line (conductors 3 and 4).

Fig. 4 shows the coupling diagram of two lines.

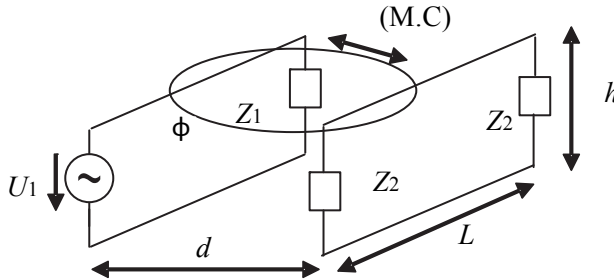

**Fig. 4** – Diagram of coupling between two lines.

From the frequency band analysis, the coupling occurs in two ways [6, 7, 10 – 16].

*Coupling Low Frequency:* in low frequency ( $L < \lambda/4$ )

Where  $\lambda$  is the wave length of the spectrum considered, the lines can be considered as being localised, coupled circuits. In this case, any propagation phenomenon (or its neglect) can rely on the classical theories of coupled lines found in the literature. It is conventional to break the coupling between two lines into two parts:

- Capacitive coupling, sensitive to high voltage variation  $\frac{\partial V}{\partial t}$  ;
- An inductive coupling, sensitive to high current variation  $\frac{\partial I}{\partial t}$  .

The actual coupling between two lines is actually the result of the contribution of the two phenomena.

*Coupling High Frequency ( $L$  closer or greater than  $\lambda$ )*

In this section, the coupling is a local phenomenon which results in radiation at the ends or related to mutual ends of different mutual along lines.

**2.2 Inductive crosstalk**

A conductor belonging to the disturbing circuit is in the same compartment as the driver belonging to the victim circuit. These two conductors are close. There is a mutual (transformative) between them, which is responsible for the coupling [7, 10 – 13]. The coupling will be even higher if the impedance of the victim circuit is low due to the effect of the loop (Fig. 5).

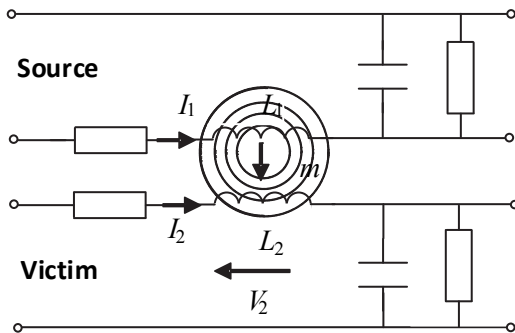

**Fig. 5 – Presentation of the inductive crosstalk.**

The magnetic crosstalk is divided between  $R_{v1}$  and  $R_{v2}$  in series (Fig. 6).

- $R_{v1}$  side: the coupling called crosstalk which can be expressed by the following relationship:

$$D_{m1} \approx 20 \log \left| \frac{V_{v1}}{V_c} \right| = 20 \log \left| \frac{M_{12} \omega}{R_{c2}} \frac{R_{v1}}{R_{v1} + R_{v2}} \right|. \quad (1)$$

–  $R_{v2}$  side: the second coupling is also called crosstalk and is expressed by the following relationship:

$$D_{m2} \approx 20 \log \left| \frac{V_{v2}}{V_c} \right| = 20 \log \left| \frac{M_{12} \omega}{R_{c2}} \frac{R_{v2}}{R_{v1} + R_{v2}} \right|. \quad (2)$$

The magnetic coupling is sensitive to  $R_{c2}$  (disturber of load impedance).

– For the case of two-wire lines this will give the following expression:

$$M_{12} \approx 0.2 \ln \left( 1 + \left( \frac{h}{S} \right)^2 \right) \quad [\mu\text{H/m}], \quad (3)$$

where  $S$  is the distance between two cables and  $h$  is the distance between two conductors of the line and where  $h/S < 1$ .

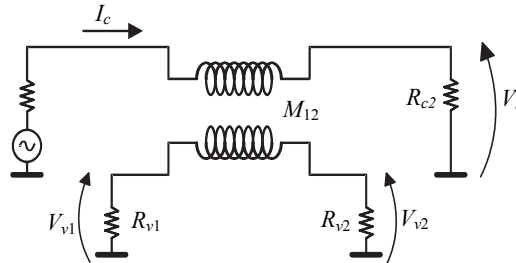

Fig. 6 – Diagram of inductive crosstalk.

### 2.3 Capacitive crosstalk

A conductor belonging to the disturbing circuit is in the same compartment as the conductor belonging to the victim circuit. These two conductors are closer and there is a capacitance between them, which is responsible for the coupling [7, 13]. The coupling will be even higher if the impedance of the victim circuit is large because of the voltage divider, consisting of the capacity and the impedance of the victim (Fig. 7).

The capacitive coupling can be expressed by the following relationship:

$$D_C = \left| \frac{V_v}{V_c} \right| = \left| \frac{R_v}{R_v + \frac{1}{jC_{12}\omega}} \right| = \frac{R_v}{\sqrt{R_v^2 + \frac{1}{(C_{12}\omega)^2}}}. \quad (4)$$

where  $V_v$  is the voltage of the victim and  $V_c$  is the voltage of the culprit.

The resulting circuit is a circuit sensitive to voltage arrester fronts, where

$$D_c = -20 \log \left( 1 + \frac{1}{R_v C_{12} \omega} \right) \quad [\text{dB}]. \quad (5)$$

At low frequencies, such as:

$$\omega \ll \frac{1}{R_v C_{12}} \quad (6)$$

$$D_c \approx 20 \log (R_v C_{12} \omega) \quad [\text{dB}], \quad (7)$$

where  $R_v = R_{v1}$ , in parallel with  $R_{v2}$  (Fig. 6).

For two-wire lines, this gives  $C_{12}$  between two pairs:

$$C_{12} \approx 27.8 \frac{1}{\left[ \ln \left( \frac{2S}{d} \right) \right]} \left[ \frac{\text{pF}}{\text{m}} \right]. \quad (8)$$

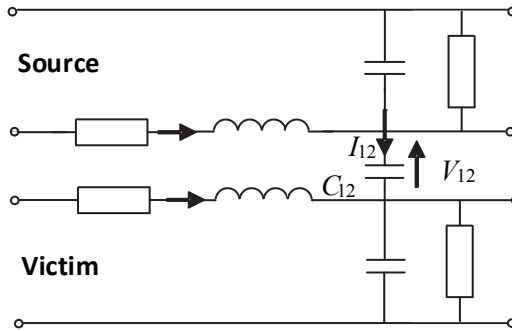

Fig. 7 – Presentation of the capacitive crosstalk.

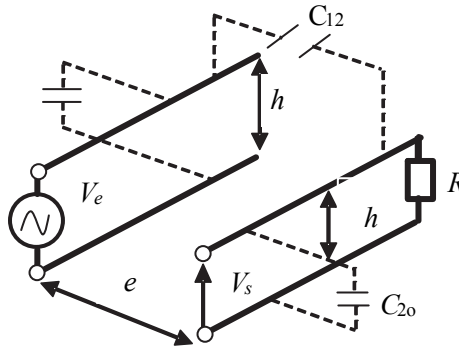

Fig. 8 – Presentation of two cables (guilty and the victim).

$S$  is the distance between two wire cables,  $d$  is the diameter of the conductor and  $R_v = R_{v1}$  in parallel with  $R_{v2}$  (Fig. 6),  $C_{12}$  is the transfer capacity between the two conductors and is proportional to the length of the conductor.

To reduce this parasitic capacitance between the guilty and the victim lines ( $C_{12}$ ), it surrounds one or both metallic screen lines to reduce the parasitic capacitance or coupling.

### 2.4 Capacitive and inductive crosstalk

Capacitive coupling occurs in parallel, while the inductive coupling is a series phenomenon. The effects of the charges on sides 1 and 2 are, therefore, of a different sign, depending on the case.

If  $D_p$  is a crosstalk phenomenon and  $D_T$  is also a crosstalk phenomenon, then the combination of both types of coupling can be expressed through the following relations:

$$D_p = \left| \frac{V_{v1}}{V_c} \right| \approx \omega \left[ R_v C_{12} + \frac{M_{12}}{R_c} \frac{R_{v1}}{R_{v1} + R_{v2}} \right], \quad (9)$$

$$D_T = \left| \frac{V_{v2}}{V_c} \right| \approx \omega \left[ R_v C_{12} - \frac{M_{12}}{R_c} \frac{R_{v2}}{R_{v1} + R_{v2}} \right]. \quad (10)$$

## 3 Coupling Cable Screened in Relation to Wire-Wire Conductor Screened

We conducted tests with two different spacings between the culprit and the victim wire cable ( $d = 6$  cm and  $d = 10$  cm) (Fig. 9). The analyser used for the measurements was vector-based networks “module and phase” measuring a transfer function  $S_{21}$  in dB ( $S_{21} =$  victim voltage / culprit voltage).

This test is performed using a vector network analyser (Fig. 10), requiring a first phase of calibration chain generation and measurements to account for losses and lengths related to the cables.

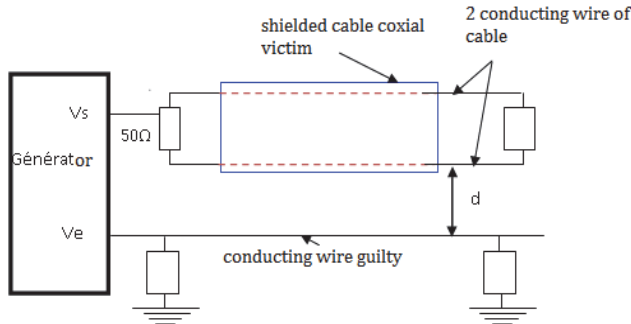
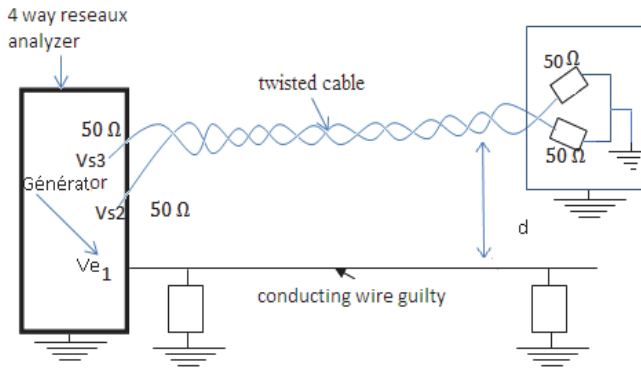

Fig. 9 – Wire test bench with shielded cable.

#### 4 Coupling Cable-Wire Twist in Relation to Unarmoured Wire Conductor Screened

We conducted a test between a single conductor, unshielded wire above a ground plane and a guilty victim twisted pair of cables length and 75 cm apart from each other;  $d = 6$  cm (Fig. 10). The four-way network analyzer used was the vector-type “module and phase” allowing transfer functions  $S_{21}$  and  $S_{31}$  measurements in dB ( $S_{21}$  = wire line victim voltage1/guilty voltage and  $S_{31}$  = voltage on victim over 2/guilty voltage) (Figs. 10 and 11).



**Fig. 10** – Test bench coupling between unshielded single wire conductor and an unshielded twisted pair of cables.



**Fig. 11** – Experimental photographic apparatus.

The twisted pair of cables has the property of minimising its radiation to the outside and reducing the influence of external sources [8].



The low coupling characteristics of twisted pairs of wires in this environment were initially investigated by Moser and Spencer, who studied the magnetic field radiated by a twisted pair [9].

The measurements were performed on a twisted pair of cables of 75 cm length. The resulting measurements were given thereafter.

## 5 Experimental results

### 5.1 Coupling of a shielded cable with or without grounding of the shield over an unshielded thread

The results are given in Figs. 12 and 13 and it can be observed from the plots that in LF (before the resonance phenomenon related to the length of the lines) coupling increases with frequency with a slope of 20 dB / decade.

The shielding with grounding protects internal lines for about 25 dB. Beyond this, the phenomena of resonance and anti-resonance lines related to terminals occur. It will provide particular safety for the connectors at the ends of lines, avoiding the coupling effect of the magnetic field through loops.

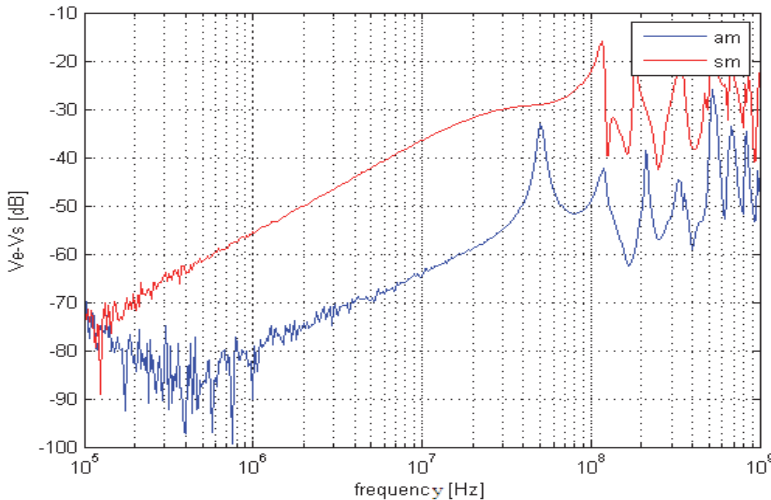

**Fig. 12** – Coupling ( $V_s/V_e$ ) in dB as a function of frequency for a distance between the shielded cable and the thread equal to 6 cm (am: with ground, sm: without ground).

The frequency of appearance of the first reflections was from 100 MHz, the value actually observed in the measurements.

The results show an attenuation of the field of 10 dB at about 100 MHz and 20 dB beyond 150 MHz, when adding the ground.

According to the results in Fig. 12, we can say that, in low frequency, there is an increase of the coupling of 20 dB with the frequency. But in high frequency, this coupling causes a resonance (maximum coupling or quarter-wave resonance) along the length of the line.

We notice that the coupling increases as the distance between disturbed and disruptive cable wires decreases.

Indeed, we have seen that the ground conductor (am) has shielding attenuation in the field of 20 dB against approximately 30 dB (500 MHz) depending on the frequency for the shielded cable.

## 5.2 Coupling of an unshielded, twisted cable pair over an unshielded thread

The bifilar, twisted or braided cables lead to lower coupling by reducing the effective area of the line.

Through developing the work outlined in [9], we can present an experimental test of our system of behaviour in differential mode (DM) and in common mode in a high frequency regime.

During normal operations, these twisted, interference signals are either superimposed on the useful signals in differential mode or common mode (Fig. 14).

The model in Fig. 14 includes two modes: the common and differential modes. The relationship between the current and voltage of this model are expressed by the following equations [9 – 10]:

$$I_{MD} = \frac{I_1 - I_2}{2}, \quad (11)$$

$$V_{MD} = V_1 - V_2, \quad (12)$$

$$I_{MC} = I_1 + I_2, \quad (13)$$

$$V_{MC} = \frac{V_1 + V_2}{2}. \quad (14)$$

Keeping the distance between pair leads allows for defining an impedance characteristic for the pair, so as to suppress the reflections of signals to connections and the end of the line.

According to the results presented in Fig. 15, where one measures the crosstalk, the interference of the differential modes can be observed, even if they are small compared to the common mode (15 to 25 dB, low frequency before the onset of resonance phenomena). They will be, a priori, more troublesome because they are in series and will be superimposed directly onto the useful signals of the twisted pair.

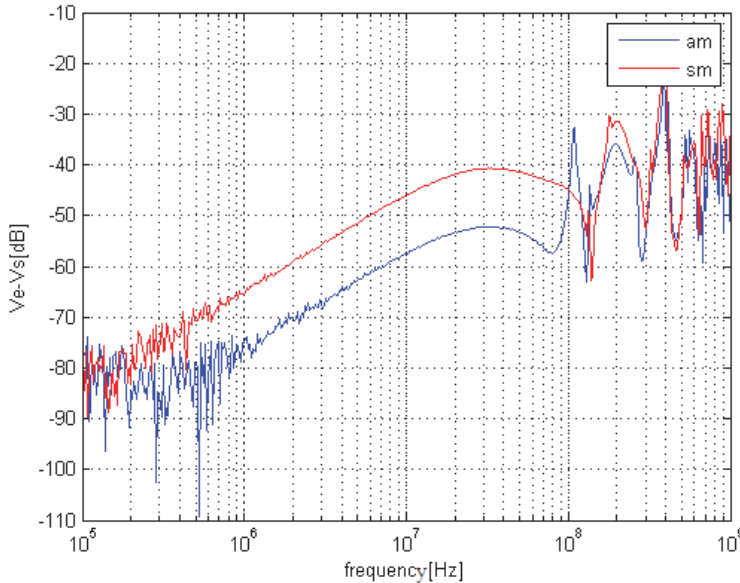

**Fig. 13** – Coupling  $V_s/V_e$  in dB depending on the frequency for a distance between the shielded cable and the thread equal to 10 cm (am: with ground, sm: without ground).

The greater the number of twists, the lower the crosstalk. The average number of twists per metre is part of the cable specification. The frequency of appearance of the first reflections is 100 MHz and above, the value actually observed in the measurements.

For the configuration in this work, it is clear from the experimental results for the frequency range considered (100 MHz – 1 GHz) that the effect of a twisted cable compared to parallel conductors is less than 20 dB, provided that the parallel cables are kept in touch.

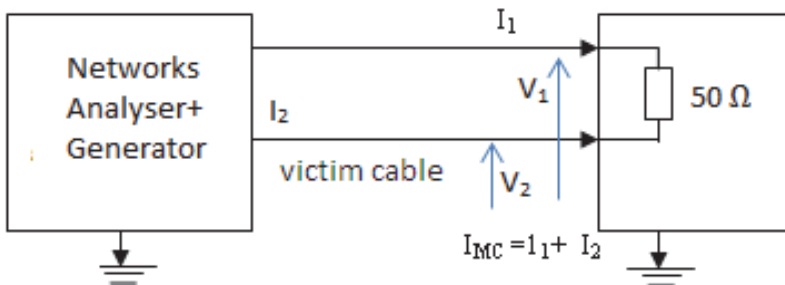

**Fig. 14** – Common Mode and Differential Mode.

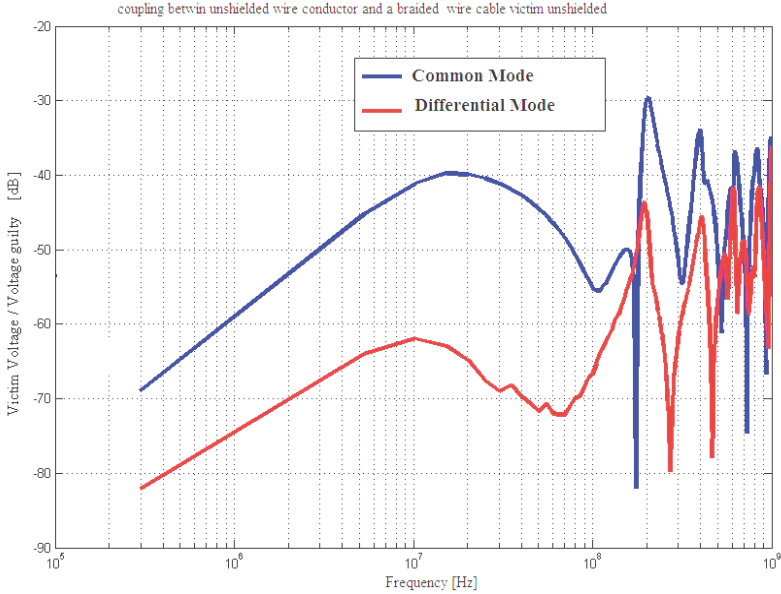

**Fig. 15** – Coupling of common mode and differential mode dB depending on the frequency, between an unshielded twisted pair cable and wire ( $d = 6$  cm).

However, common mode disturbances are generally at the highest amplitudes, with respect to the differential mode. These can become a part of differential mode whenever there is an imbalance in the input impedances of the electronic systems (capacitive effect of a different line from the other relative to the ground, or an inductive effect due to the difference of the length of lines or rays (crushing)).

The results show a much larger amplitude of the field (30 dB at 150 MHz and more) in the monofilar case with mass. For the twisted cable, in common mode, the amplitude of the field is indeed greater than that of the monofilar case for a similar radiation topology.

## 6 Conclusion

The capacitive and inductive crosstalks intervene as soon as the conductors have close parallel paths. They are, therefore, likely to apply in all cable trays or troughs, especially between cables carrying radio frequency interference (e.g. a lightning disturbance duct or radiator) and conductor pairs in a network.

In this paper, the effect of shielding on reducing coupling and, especially, the importance of grounding the shield has been investigated and experimentally studied.

We also measured the common-mode currents and differential mode with a bank of adequate measures involving a four lines vector network analyser, allowing us to carry out accurate measurements before performing a calibration phase necessary when working with HF. The electromagnetic disturbance and their effects have been highlighted in this study.

Future work will consist of extending our analysis to a complex bundle, composed of many twisted cables around an electronic power environment. On the one hand, a more specific approach to the management of the problem of electromagnetic disturbances will be developed. On the other hand, the application of equivalent and simplified models will also be studied experimentally.

In order to complete the present work, and according to the work of C. Jullien et al., the simulation models and experimental results will be studied for future research.

## 7 References

- [1] W. Yannick: Power Cable Modeling under Power Electronic Converter Constraints, Ph. D. Dissertation, The University of Lille, Lille, France, 2006. (In French).
- [2] J.- M. Escané, P. Escané: Modeling of Lines and Cables, Engineering Techniques – Electrical Engineering, No. D1102, August 2001, pp. 1 – 18. (in French).
- [3] A. Charoy: Electromagnetic Compatibility, 2nd Edition, Dunod, Malakoff, France 2012. (In French).
- [4] C. Jullien, P. Besnier, M. Dunand, I. Junqua: Crosstalk Analysis in Complex Aeronautical Bundle, Proceedings of the International Symposium on Electromagnetic Compatibility, (EMC EUROPE 2013), Bruges, Belgium, September 2013, pp. 253 – 258.
- [5] C. Briellmann Leitungstheorie, G. S. Moschytz, U. Brugger J. Rosenblatt: Transmission on Lines, 1998. Available at:  
<http://ivanlef0u.fr/repo/madchat/coding/electro/Transmission%2520sur%2520lignes.pdf>
- [6] G. Angénieux: Transmission Lines in Harmonic and Transient Regime, University of Savoy, France, 2009.
- [7] H. Slimani, A. Bendaoud, H. Miloudi, A. Dahak, M. Miloudi: Low Frequency Disturbances in Distribution Electricity Networks, Proceedings of the 8th International Electrical Engineering Conference (CEE'2014), Batna, Algeria, October 2014, pp. 1 – 5. (In French).
- [8] H. Slimani, A. Bendaoud, H. Miloudi, K. Medles M. Miloudi: Electromagnetic Interference in a Cable Feeding an Asynchronous Motor, Proceedings of the International Conference on Automation and Mechatronics (CIAM'11), Oran, Algeria, November 2011, pp. 1 – 6.
- [9] H. Slimani, A. Bendaoud, N. Chikhi, H. Miloudi, M. Miloudi: Estimation of Disturbances Conducted in Power Lines of Electric Power, Proceedings of the 8th International Electrical Engineering Conference (CEE'2014), Batna, Algeria, October 2014. (In French).
- [10] C. R. Paul: Analysis of Multiconductor Transmission Lines, 1st edition, John Wiley & Sons, Inc., New York, USA, 1994.

- [11] A. Bendaoud, H. Slimani, F. Benhamida, Z. Ayache, H. Miloudi, K. Medles: Electromagnetic Disturbances Near Energy Lines Carrying HF Signals, TELECOM2011 & 7ème JFMMA, Tanger, Morocco, March 16–18 2011. (In French).
- [12] P. Besnier, C. Jullien, M. Dunand, I. Junqua: Theoretical and Experimental Analysis of the Coupling between an Unshielded Twisted Pair and a Single-Wire Cable, Proceedings of the 16th International Symposium on Electromagnetic Compatibility (CEM 2012), Rouen, France, April 2012, pp. 1–6. (In French).
- [13] C. Jullien, P. Besnier, M. Dunand, I. Junqua: Advanced Modeling of Crosstalk between an Unshielded Twisted Pair Cable and an Unshielded Wire Above a Ground Plane, IEEE Transactions on Electromagnetic Compatibility, Vol. 55, No. 1, February 2013, pp. 183–194.
- [14] P. Lagonotte, F. Ndaguimana: Propagation Modeling on Electrical Lines, Proceedings of the 10th International Symposium on Electromagnetic Compatibility (CEM 2000), Clermont-Ferrand, France, March 2000, pp. 110–114. (In French).
- [15] T. Raminosa: Quadrupole Modeling of Long Cables Connecting Converter and Machine: Time and Frequency Analysis, Proceedings of the Conference of Young Researchers in Electrical Engineering (JCGE'13), Saint-Nazaire, France, June 2003. (In French).
- [16] B. Benazza, A. Bendaoud, H. Slimani, F. Benhamida, H. Miloudi, A. Tilmatine: Electromagnetic Radiation in Low Voltage Bundles, Proceedings of the International Conference on Electrical Networks (ICEN'10), Sidi Bel-Abbès, Algeria, September 2010, pp. 286–291. (In French).
- [17] B. Revol: Modeling and Optimization of the EMC Performances of a Speed Variator Association – Asynchronous Machine, Ph. D. Dissertation, Joseph Fourier University, Grenoble, France, 2004.
- [18] H. Slimani, A. Bendaoud, B. Benazza, F. Benhamida, H. Miloudi, A. Tilmatine: Behavior and Calculation of the Electromagnetic Field Generated Near an Energy Line Carrying HF Signals, Proceedings of the International Conference on Electrical Networks (ICEN'10), Sidi Bel-Abbès, Algeria, September 2010, pp. 182–187. (In French)
- [19] P. Degauque, A. Zeddou: Electromagnetic Compatibility 2: Concepts to Applications, Edited by Hermes, Paris, France, 2007.
- [20] S. T. Tran, E. Clavel, C. Fiachetti: Experimental Comparison of Wiring Configurations, Proceedings of the 15th International Symposium on Electromagnetic Compatibility (CEM 2010), Limoges, France, April 2010, pp. 1–6. (In French).